

# Aesculap Surgical Instruments

Surgical Instrument Catalog Supplement







# Table of Contents

Scissors .....	4 - 6
Needle Holders .....	7
Knives .....	8
Forceps .....	9 - 14
Clamps .....	15 - 19
Retractors .....	20 - 24
Specula .....	25
Speculums .....	26
Probes .....	27
Knife Handles .....	27
Suction Tubes .....	28
Nasal Rasps .....	29
Mallets .....	30
Curettes .....	30 - 31
Director .....	32
Dissectors .....	32 - 33
Elevators .....	34
Excavators .....	34
Hooks .....	35
Impactors .....	35
Osteotomes .....	35 - 36
Picks .....	36 - 37
Scoops .....	37
Gouges .....	37
Tuning Fork .....	38
Wire Cutters .....	38
Wire Twister .....	38
Miscellaneous .....	39
V. Mueller - Aesculap Cross Reference List .....	40 - 43
Jarit - Aesculap Cross Reference List .....	44 - 45
Pilling Weck - Aesculap Cross Reference List .....	46 - 47
Codman - Aesculap Cross Reference List .....	48
Index .....	50 - 51

# Scissors



MB049R

1/2

WIET Bayonet Otolgic Scissors

Item No.	Blade	Length (in.)
MB049R	Straight	6 1/2"

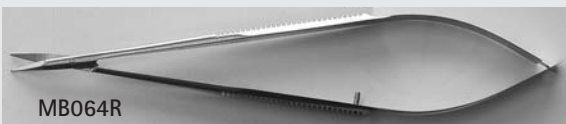

MB064R

1/2

Valve Leaflet Excision Scissors

Item No.	Blade	Length (in.)
MB064R	45° Angle	5 3/4"



MB065R

1/2

Arteriotomy Finger POTTS Scissors

Item No.	Blade	Length (in.)
MB065R	60° Angle	5 3/8"



MB109R

1/2

KAYE Face-Lift Scissors

Item No.	Blade	Length (in.)
MB109R	Curved Serrated	7 1/2"

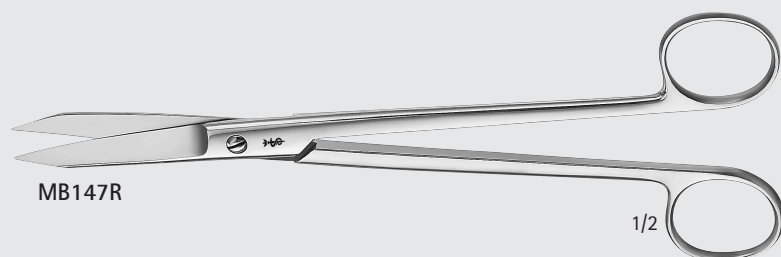

MB147R

1/2

MARTIN Cartilage Scissors

Item No.	Blade	Length (in.)
MB147R	Curved Serrated	8"



# Scissors

## MAYO Dissecting Scissors

Item No.	Handle	Length (in.)
MB148R	One Large Ring Heavy Blades	14"

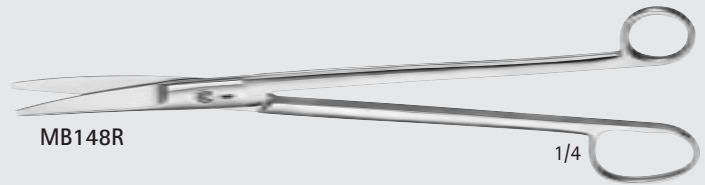

## JOSEPH Scissors

Item No.	Tip	Blade	Length (in.)
MB174R	S/S	Straight Serrated	5 1/2"
MB175R	S/S	Curved Serrated	5 1/2"

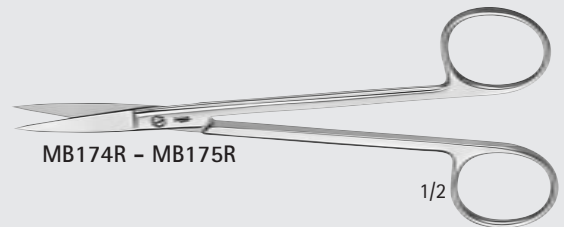

## TC FOMON Dorsal Scissors

Item No.	Blade	Length (in.)
MB540R	30° Angle	5 1/4"

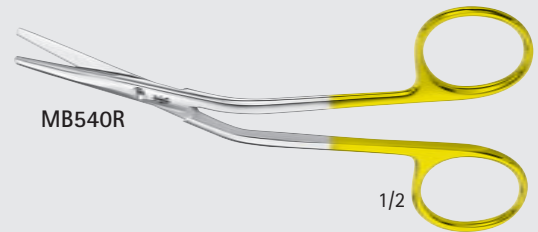

## MAYO-SIMS Dissecting Scissors

Item No.	Tip	Blade	Length (in.)
MB149R	B/B	Straight	7 3/4"

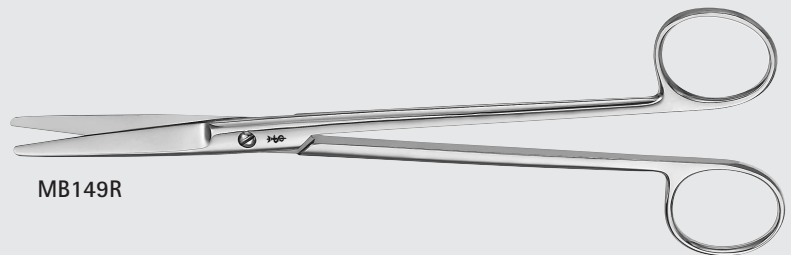

## TC METZENBAUM Dissecting Scissors

Item No.	Tip	Blade	Length (in.)
MB207R	S/S	Delicate Curved	5 3/4"
MB206R	S/S	Delicate Curved	9 1/4"
MB205R	S/S	Delicate Straight	9 1/4"



# Scissors

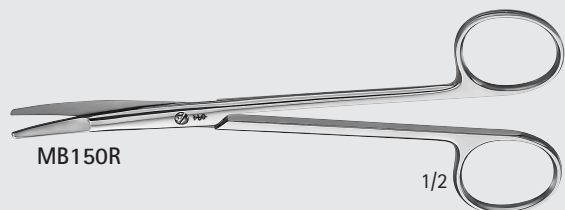

**METZENBAUM-LIPSETT Scissors**

Item No.	Blade	Length (in.)
MB150R	Curved	5 1/2"



**TC Operating Scissors**

Item No.	Tip	Blade	Length (in.)
MB171R	S/S	Curved	5 3/4"

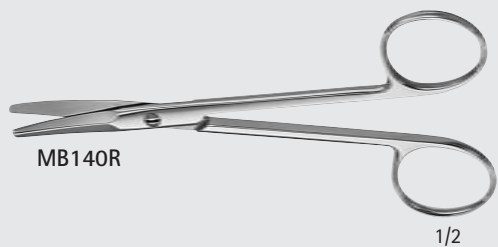

**FOMON Saber-Back Scissors**

Item No.	Blade	Length (in.)
MB140R	Serrated Curved	5"

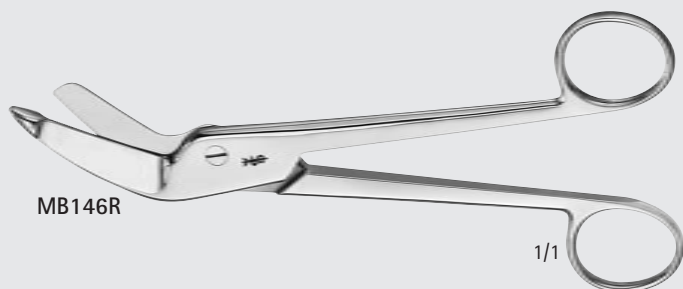

**LISTER Bandage Scissors**

Item No.	Blade	Length (in.)
MB146R	Angled	3 1/2"



**HERCULES Plaster Shears**

Item No.	Length (in.)
MB106R	7 1/2"



# Needle Holders

TC COOLEY Intracardiac Needle Holders

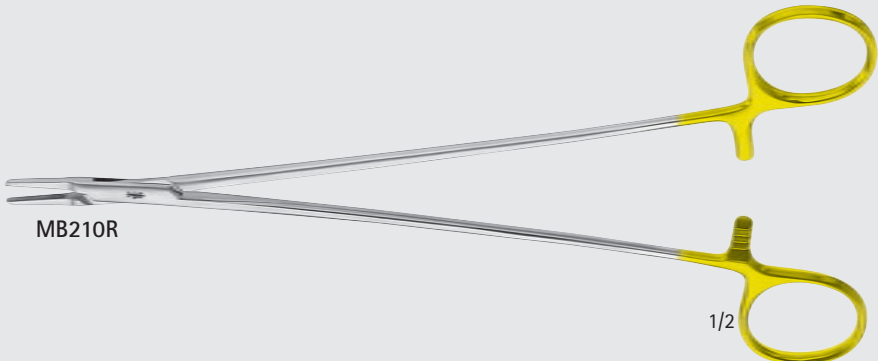

Item No.	Jaw	Length (in.)
MB210R	Straight	9"

TC JACOBSON Needle Holders

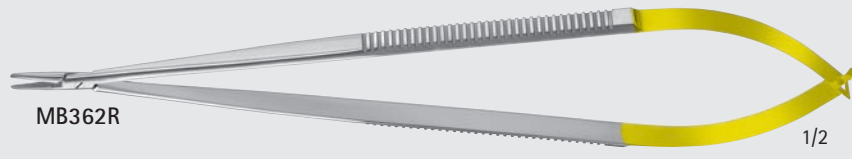

Item No.	Jaw	Length (in.)
MB362R	Straight	8 3/4"

# Knives

## BALLENGER Swivel Knives

Item No.	Blade	Length (in.)
MB118R	Straight, 4 mm	7 3/4"
MB119R	Straight, 3 mm	7 3/4"



MB118R - MB119R

1/2

## PAPARELLA Sickle Knives

Item No.	Knife	Length (in.)
MB282R	#14 Right	6 1/2"
MB283R	#15 Left	6 1/2"



MB282R - MB283R

1/1





# Forceps

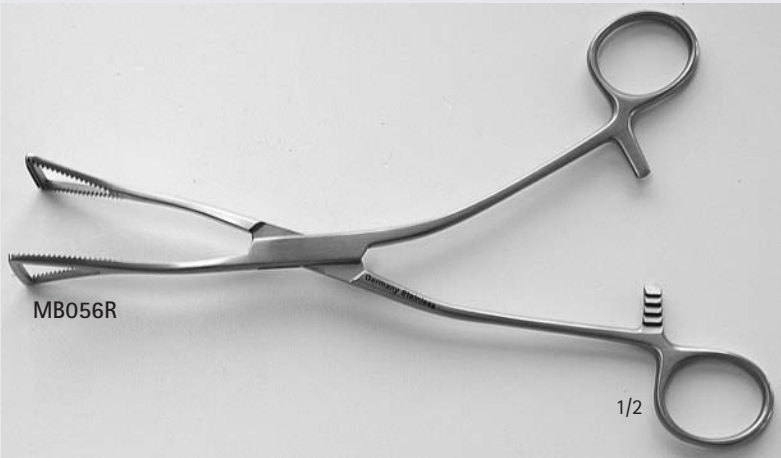

**LOVELACE Lung Forceps**

Item No.	Shank	Jaw	Length (in.)
MB056R	Angled	25°	8"



**BABCOCK Thoracic Tissue Forceps**

Item No.	Jaw	Length (in.)
MB057R	16 mm	9 1/2"



**MIXTER Thoracic Forceps**

Item No.	Jaw	Length (in.)
MB059R	Right Angled Serrated	14"

# Forceps

## KANTROWITZ Dressing Forceps

Item No.	Tip	Jaw	Length (in.)
MB061R	Curved	Angled	12"

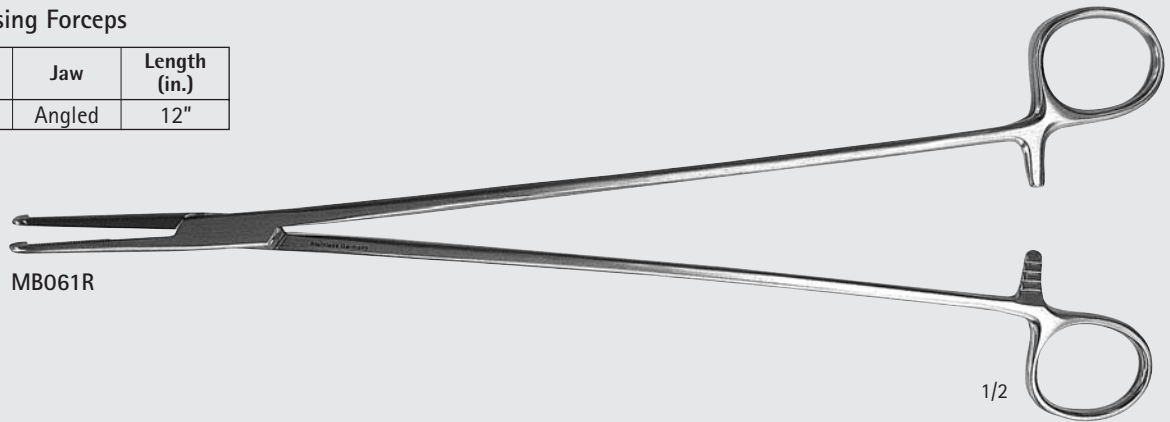

## DEBAKEY Tissue Forceps

Item No.	Jaw	Length (in.)
MB062R	2 mm	14"

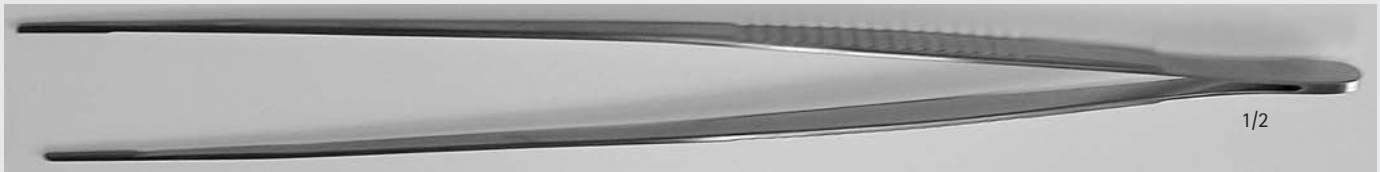

## FOERSTER Sponge Forceps

Item No.	Jaw	Length (in.)
MB098R	Straight Serrated	12"
MB099R	Straight Serrated	14"

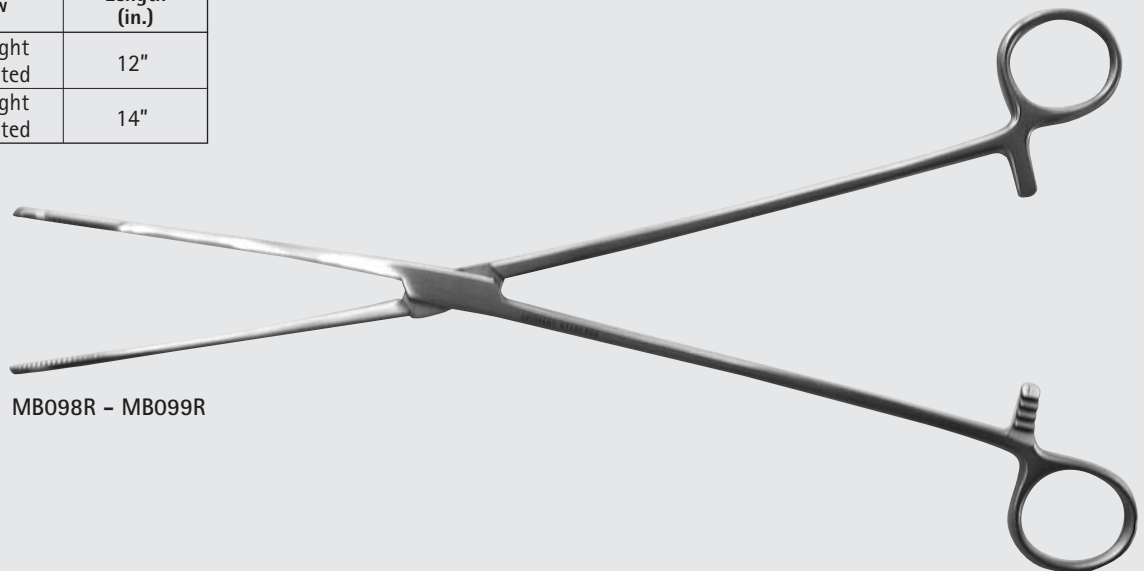



# Forceps

## MIXTER Gall Duct Forceps

Item No.	Jaw	Length (in.)
MB120R	Fully Curved	6 1/4"

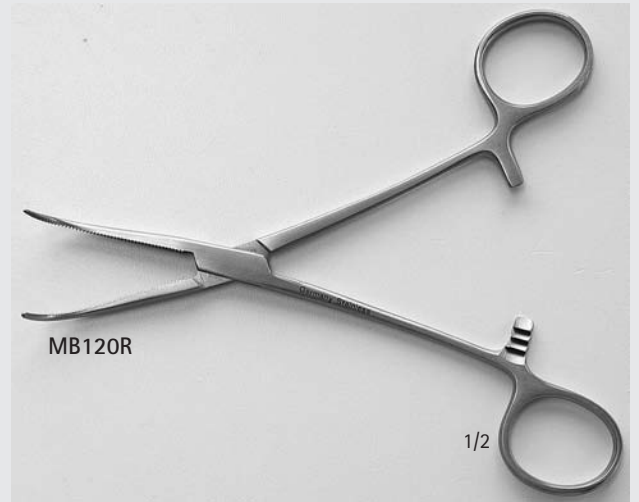

## SHALLCROSS Cystic Duct Forceps

Item No.	Jaw	Length (in.)
MB126R	Fully Curved	6 7/8"



## PEAN Artery Forceps

Item No.	Jaw	Length (in.)
MB128R	Straight	12"
MB180R	Curved	12"
MB181R	Curved	14"



# Forceps

## BABCOCK Tissue Holding Forceps

Item No.	Length (in.)
MB136R	12"
MB137R	14"

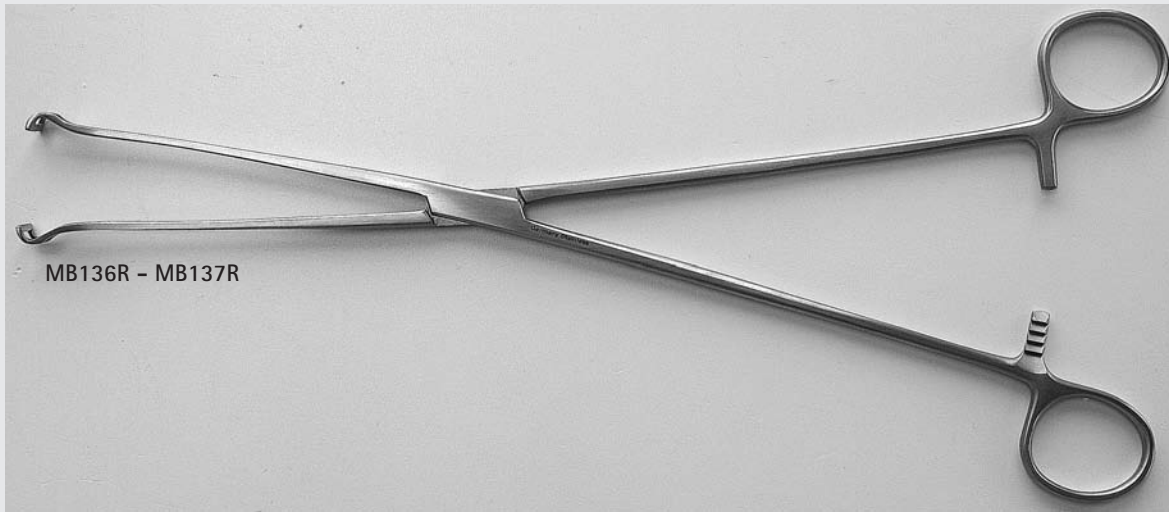

## TC BABCOCK Forceps

Item No.	Length (in.)
MB338R	8 1/4"

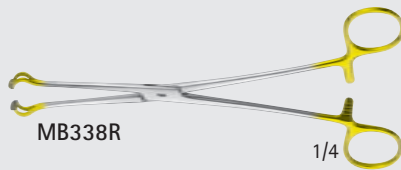

## ROCHESTER-OCHSNER Artery Forceps

Item No.	Jaw	Length (in.)
MB172R	1 x 2 Teeth Straight	14"

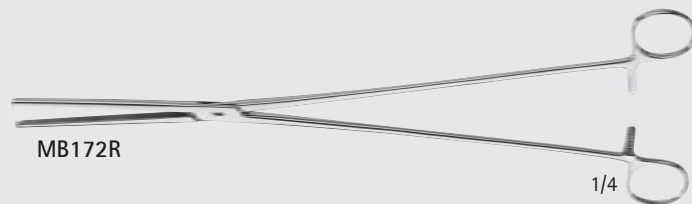

## CARMALT Artery Forceps

Item No.	Jaw	Length (in.)
MB182R	Curved	12"

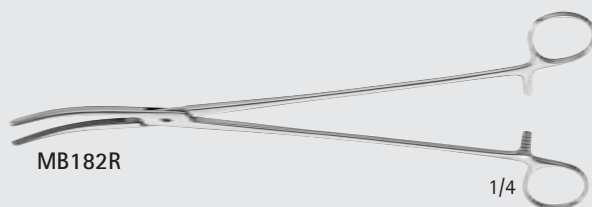



# Forceps

## McHENRY Tonsil Artery and Sponge-Holding Forceps

Item No.	Length (in.)
MB533R	8"



## WEINGARTNER Ear Forceps

Item No.	Length (in.)
MB289R	3 1/8"

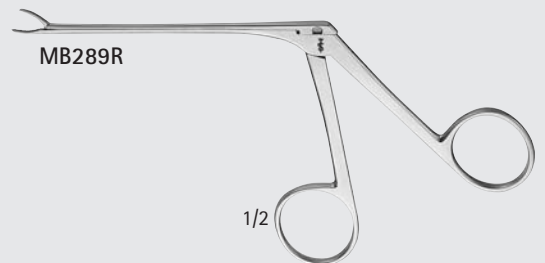

## BRAND Tendon Tunneling or Passing Forceps

Item No.	Jaw	Length (in.)
MB105R	Curved	9 1/4"

MB105R - Picture not available

# Forceps



C.W MAYO Tissue Forceps

Item No.	Jaw	Length (in.)
MB208R	Fenestrated	9"



DOCKTOR Forceps

Item No.	Teeth	Length (in.)
MB211R	1 x 2	4 3/4"



TC Cushing Tissue Forceps

Item No.	Tip	Length (in.)
MB308R	Angled	6 3/4"

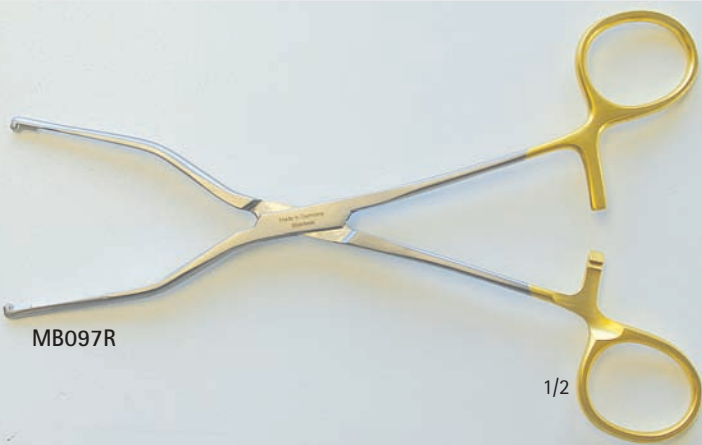

Fogarty Spring Clip Applicator Forceps

Item No.	Length (in.)
MB097R	7 1/4"



# Clamps

## KANTROWITZ Thoracic Clamps

Item No.	Jaw	Length (in.)
MB058R	Right Angled Serrated	6 3/8"

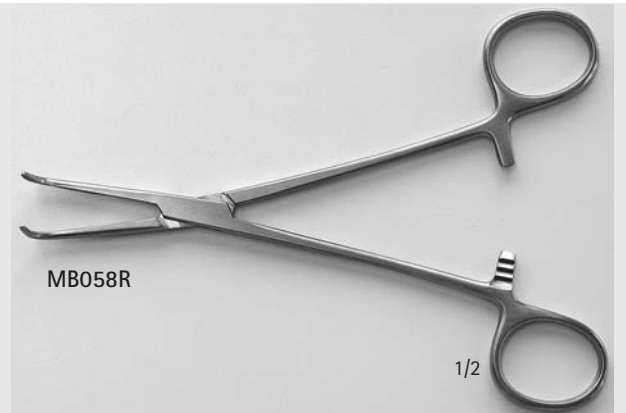

## Fogarty Hydragrip Clamps

Item No.	Jaw	Length (in.)
MB092R	Angled	4 5/8"
MB091R	Straight	6 1/2"
MB094R	Angled	8 1/2"
MB093R	Angled	8 3/4"
MB095R	Angled	9 1/4"
MB096R	Straight	12 1/4"

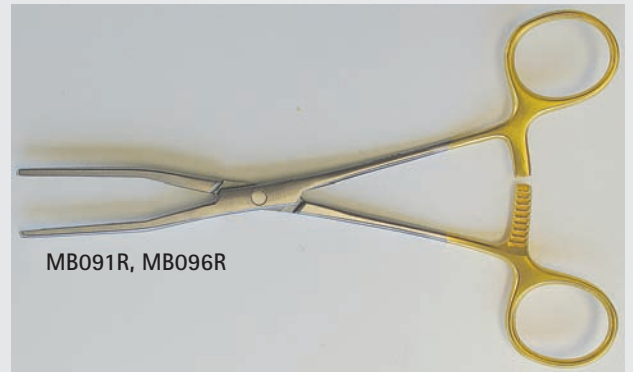

## GLASSMAN Anterior Resection Clamps

Item No.	Jaw	Length (in.)
MB130R	2" Right Angle Fully Serrated	9 3/4"



# Clamps

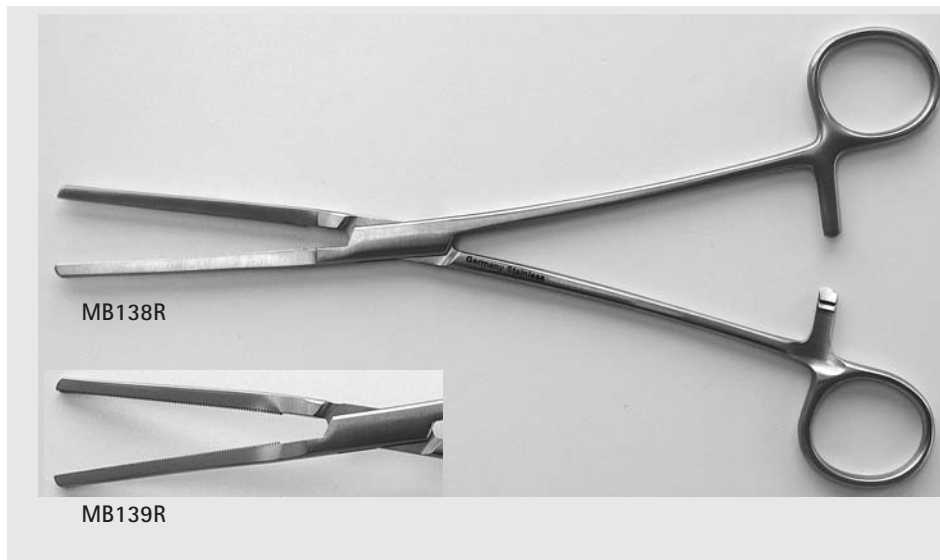

GLASSMAN Non-Crushing Gastrointestinal Clamps

Item No.	Blade	Length (in.)
MB138R	Straight	9 1/4"
MB139R	Angled	9"

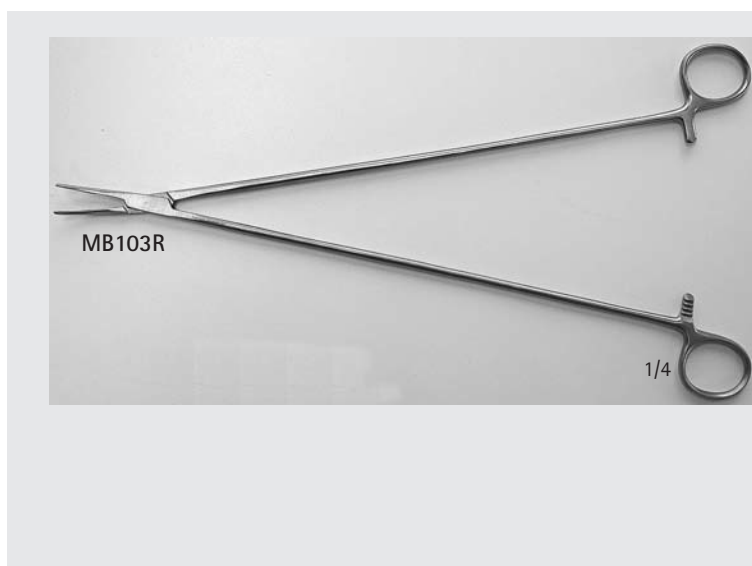

Tonsil Clamps

Item No.	Length (in.)
MB103R	14 1/2"



COOLEY Bulldog Clamps

Item No.	Jaw	Length (in.)
MB586R	Curved, Serrated	1 3/4"
MB587R	Curved, Serrated	2 1/2"
MB588R	Curved, Serrated	3 1/8"





# Clamps

## COOLEY Coarctation Clamps

Item No.	Jaw	Length (in.)
MB350R	Straight 50 mm	8 3/4"

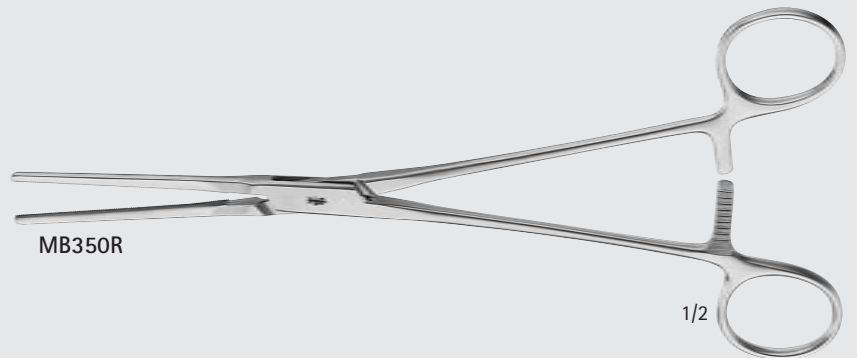

## COOLEY Caval Occlusion Clamps

Item No.	Blade	Length (in.)
MB580R	28FR	8 1/4"
MB581R	32FR	8 1/4"
MB582R	34FR	8 1/4"



## GREGORY DeBAKEY Bulldog Clamps

Item No.	Angle	Jaw	Length (in.)
MB523R	45°	70 mm	4 3/4"



# Clamps

## Uterine Clamps

Item No.	Jaw	Length (in.)
MB352R	Straight	9 1/2"
MB353R	Slight-Curved	9 1/2"
MB354R	Curved	9 1/2"
MB355R	Angled	9 1/2"
MB183R	Curved	12"
MB184R	Angled	12"
MB187R	Straight	12"
MB188R	Slight-Curved	12"
MB185R	Straight	14"
MB186R	Slight Curved	14"

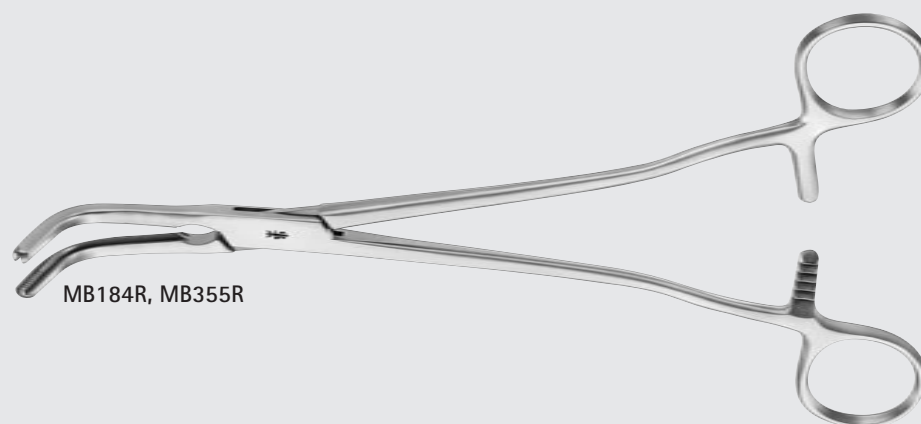
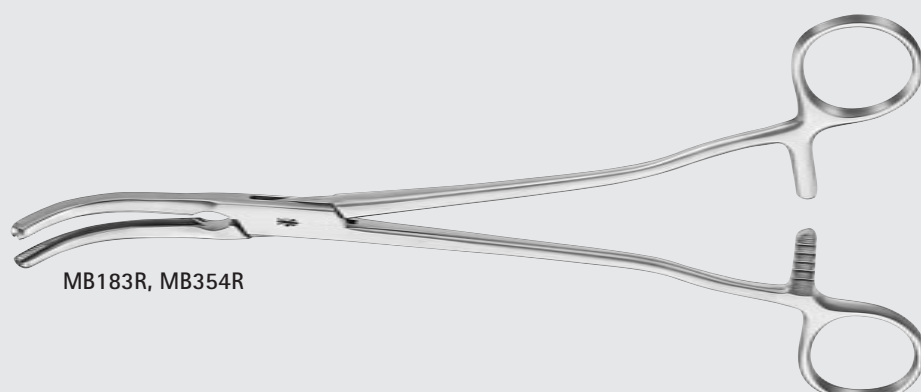
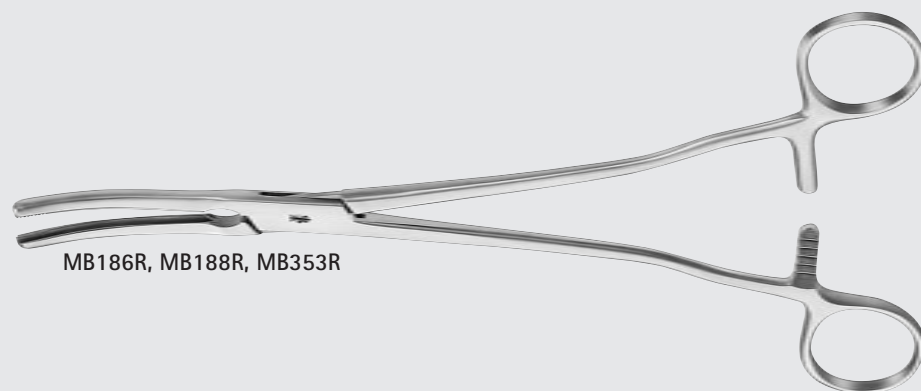
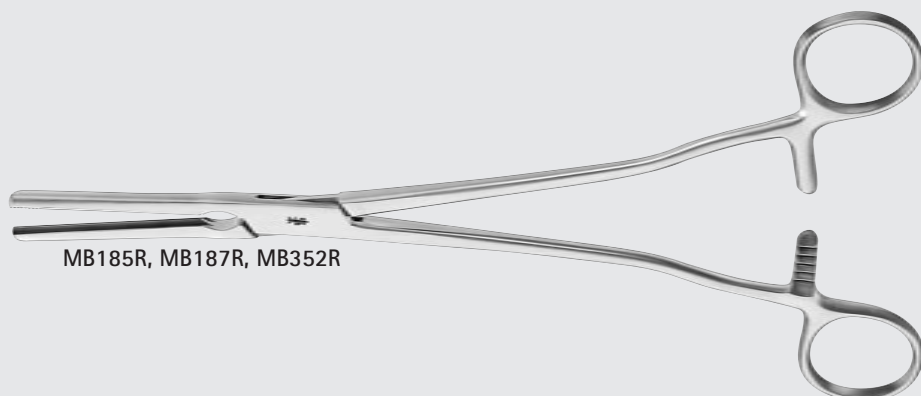



# Clamps

## COOLEY Curved Cardiovascular Clamps

Item No.	Jaw	Length (in.)
MB348R	Curved	8 1/4"

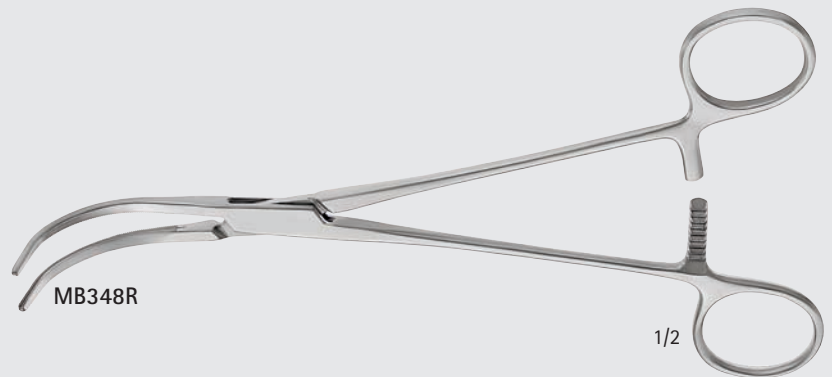

## COOLEY Aorta Clamps

Item No.	Jaw	Length (in.)
MB349R	Curved	10"

MB349R - Picture not available

## COOLEY Multi-Purpose Curved Clamps

Item No.	Jaw	Length (in.)
MB528R	Curved	8" (200 mm)



## PRICE Muscle Biopsy Clamps

Item No.	Jaw
MB200R	8 mm Double-Prong

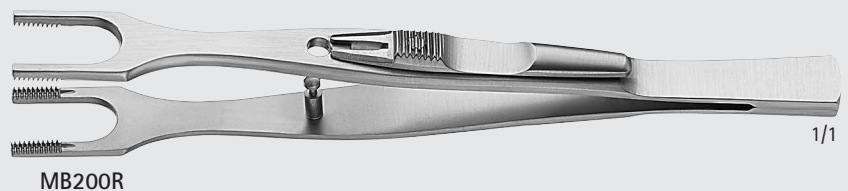

# Retractors

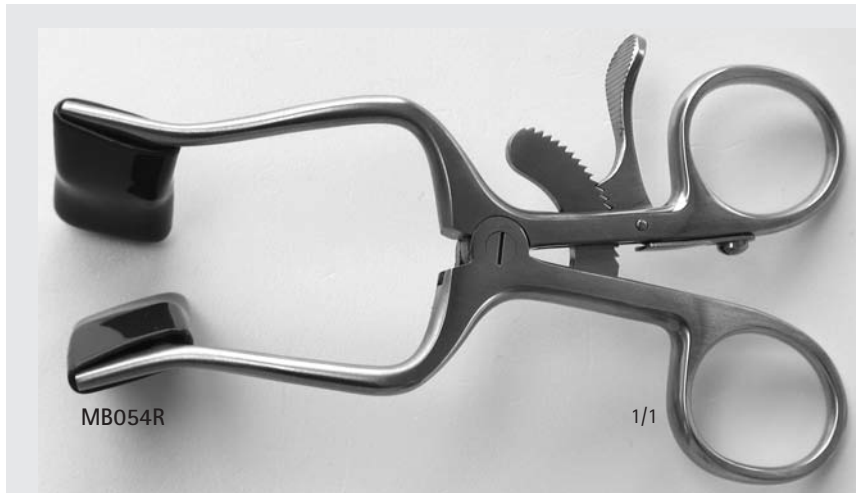

## WULLSTEIN Retractors

Item No.	Prongs	Length (in.)
MB054R	3 x 3, Blunt	4 1/8"



## DE LEE Universal Retractors

Item No.	Blade	Length (in.)
MB068R	69 mm x 50 mm	9 1/2"

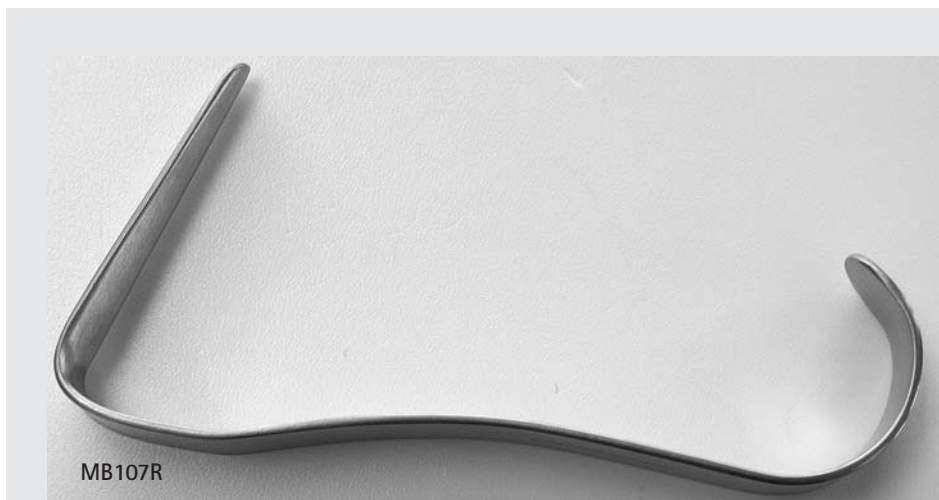

## CONVERSE Nasal Retractors

Item No.	Blade	Length (in.)
MB107R	44 mm x 11 mm	4 1/2"



# Retractors

## MAYO-COLLINS Appendectomy Retractors

Item No.	Length (in.)
MB129R	6 3/4"

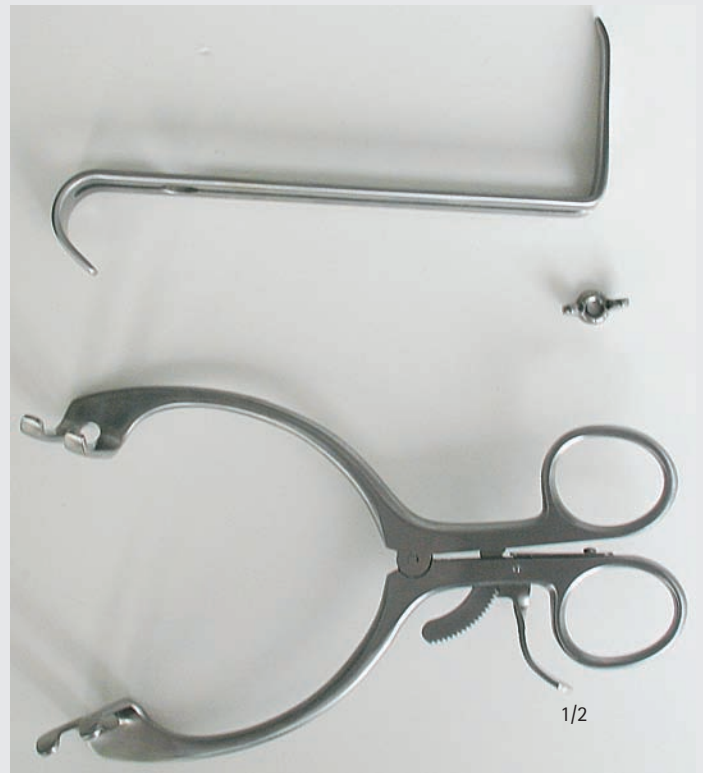

MB129R

## ROSS Aortic Valve Retractors

Item No.	Blade	Length (in.)
MB700R	#3	10"
MB701R	#4	10 1/8"
MB702R	#5	10 1/8"
MB703R	#6	10"



MB700R - MB703R

## ROUX Retractors, Double-end

Item No.	Blade	Length (in.)
MB584R	25 x 35 mm	6 1/2"
MB585R	29 x 40 mm	6 1/2"



MB584R - MB585R

1/2

# Retractors

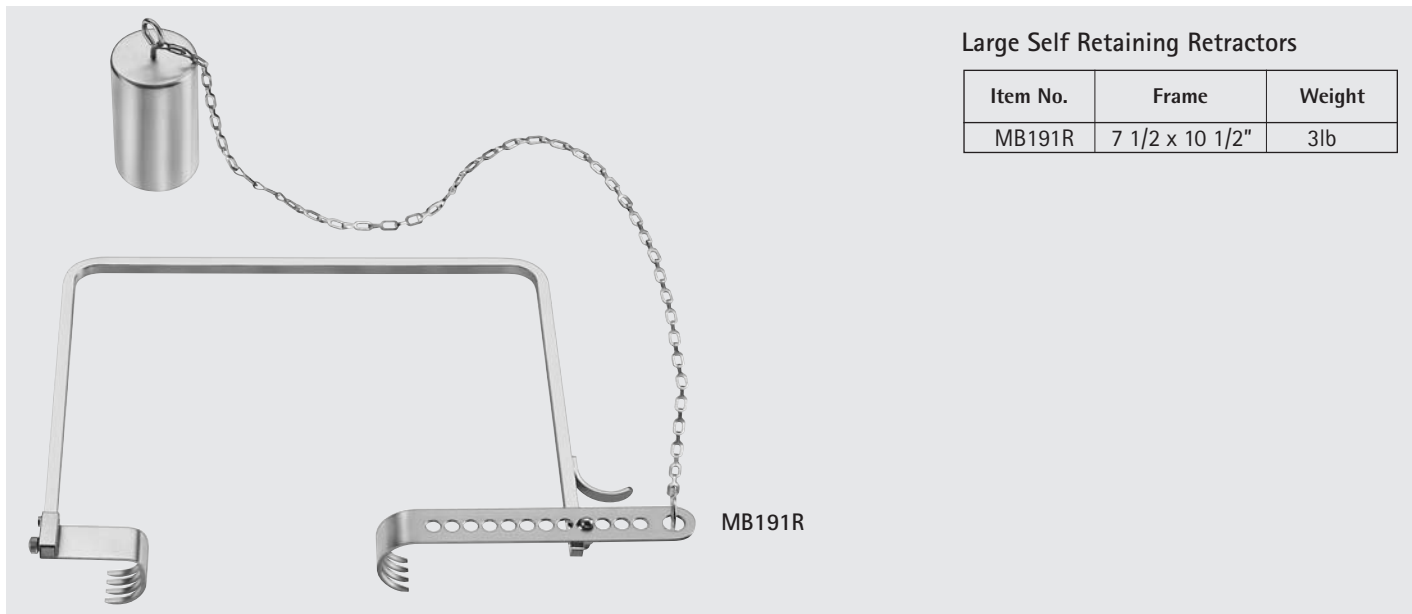

Large Self Retaining Retractors

Item No.	Frame	Weight
MB191R	7 1/2 x 10 1/2"	3lb

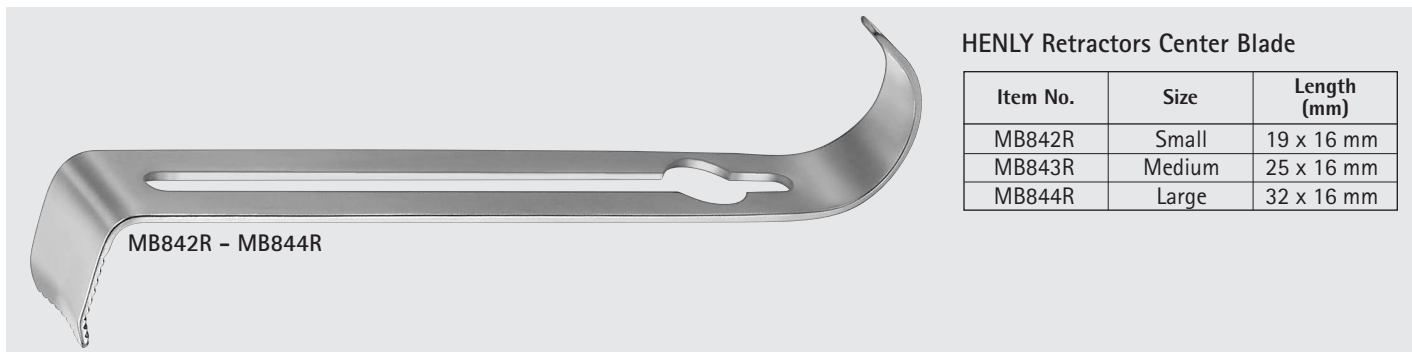

HENLY Retractors Center Blade

Item No.	Size	Length (mm)
MB842R	Small	19 x 16 mm
MB843R	Medium	25 x 16 mm
MB844R	Large	32 x 16 mm

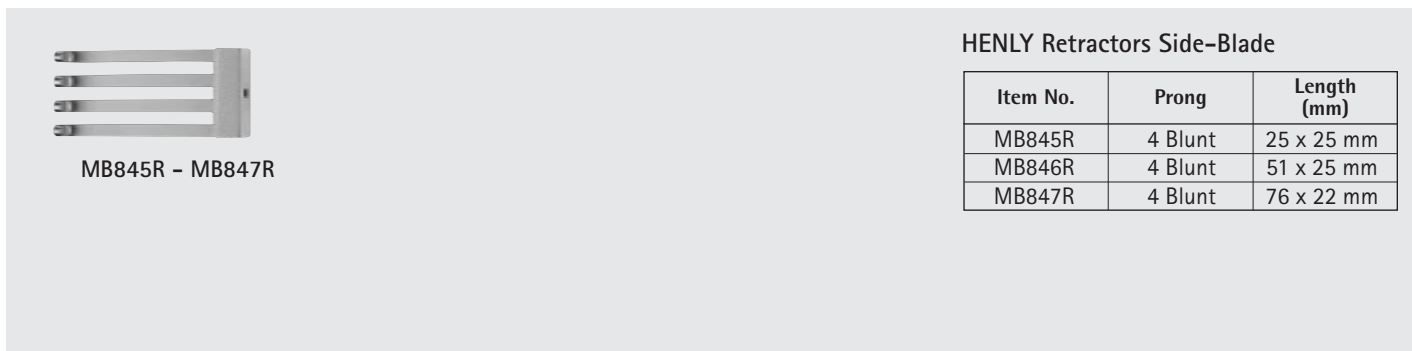

HENLY Retractors Side-Blade

Item No.	Prong	Length (mm)
MB845R	4 Blunt	25 x 25 mm
MB846R	4 Blunt	51 x 25 mm
MB847R	4 Blunt	76 x 22 mm

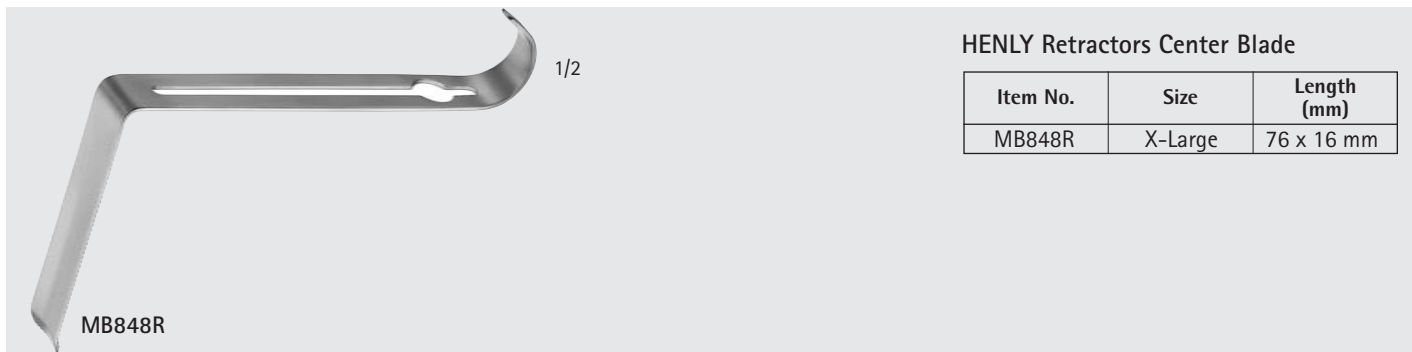

HENLY Retractors Center Blade

Item No.	Size	Length (mm)
MB848R	X-Large	76 x 16 mm



# Retractors

## HENLY Retractors Frame Only

Item No.	Length (in.)
MB849R	7"

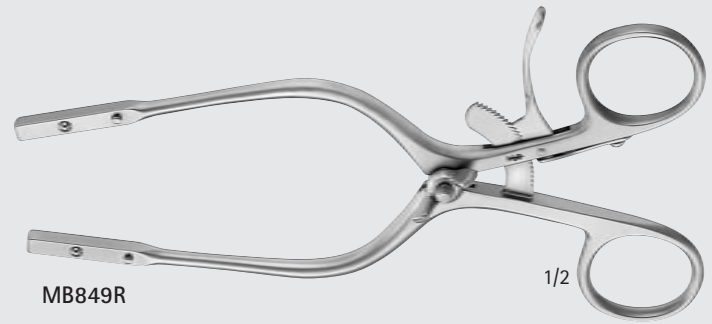

## Spring Wire Retractors

Item No.	Size	Prongs	Length (in.)
MB194R	2	3 x 3	3 1/2"
MB195R	3	4 x 4	4 1/2"

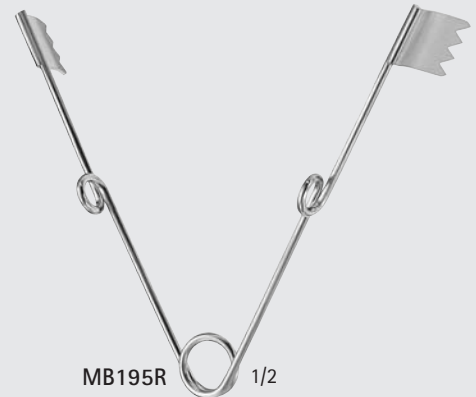

## AUFRANC Cobra Retractors

Item No.	Tip	Length (in.)
MB379R	Serrated Blunt	10"
MB448R	Smooth Pointed	10"
MB514R	Smooth Blunt	10"

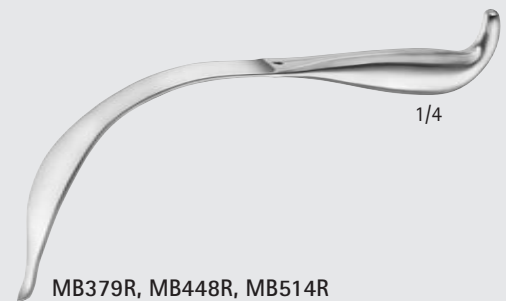

# Retractors



## HOHMANN Retractors

Item No.	Blade	Length (in.)
MB449R	15 mm	6"

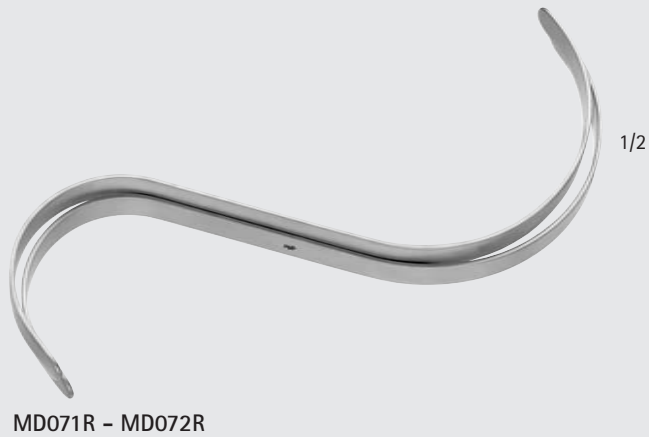

## HASSON S Retractors

Item No.	Prong
MD071R	10 mm Rigid
MD072R	13 mm Rigid

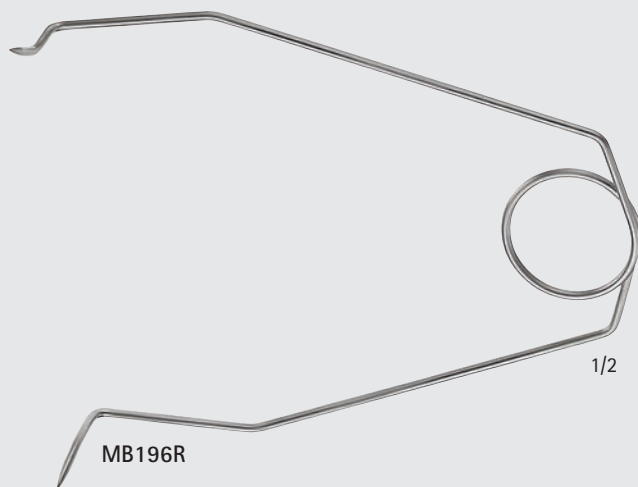

## Spring Wire Retractors

Item No.	Prongs	Length (in.)
MB196R	Large	9"





# Specula

## PEDERSON Vaginal Specula, Small

Item No.	Length (in.)
MB066R	3" x 1/2"



## GRUBER Ear Specula

Item No.	Size	Length (mm)
MB242R	Small	2 x 2.5 mm
MB243R	Medium	2.5 x 3 mm
MB244R	Large	3 x 4 mm



## BRINKERHOFF Rectal Specula

Item No.	Size	Diameter	Length (in.)
MB284R	Large	19 x 32 mm	4 1/2"



# Speculums



SONNENSCHN Nasal Speculum

Item No.	Size	Blade	Length (in.)
MB318R	Medium	27 x 5 mm	6"



Rectal Speculum

Item No.	Diameter (cm)	Length (in.)
MB274R	33 mm	2 3/8"



PETERSON Vaginal Speculum, Large

Item No.	Length (in.)
MB067R	4 3/4" x 1"



# Probes

## BUNNELL Dissecting Probes

Item No.	Tip	Length (in.)
MB456R	Angled	5 1/2"



## BUNNELL Tendon Passers & Forwarding Probes

Item No.	Length (in.)
MB363C	7 3/8"

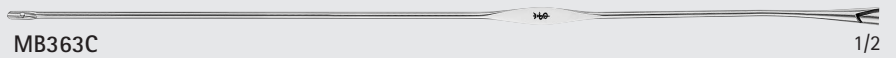

# Knife Handles

## No. 3H Knife Handle

Item No.	Shape	Length (in.)
MB104R	Hexagonal	4"



## No. 3LA Knife Handle

Item No.	Shape	Length (in.)
MB127R	Long, Angled	8"



# Suction Tubes

## YANKAUER Suction Tubes

Item No.	Jaw	Length (in.)
MB051R	Slight Curve	14"



## Suction Handle with Thumb Control

Item No.	Length (in.)
MB052R	6 7/8"



## YANKAUER Suction Tubes, Chrome Plated

Item No.	Length (in.)
MB053R	6 5/8"



## HOUSE Suction Tubes

Item No.	Tube	Length (in.)
MB614R	18GA	4 1/8"
MB615R	20GA	4 1/8"
MB616R	22GA	4 1/8"



## JACKSON Velvet Eye Aspirating Tubes

Item No.	Diameter	Length (in.)
MB366R	4 mm	10"
MB367R	4 mm	16 3/8"
MB369R	4 mm	18 1/8"
MB368R	4 mm	22"

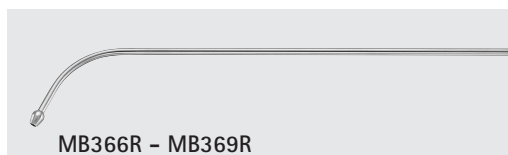

## BARON Suction Tubes

Item No.	Tube	Length (in.)
MB380R	3FR	4"
MB381R	5FR	4"
MB382R	7FR	4"

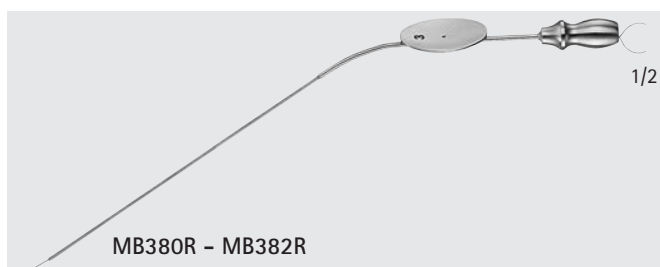



# Nasal Rasps

## MALTZ-ANDERSON Nasal Rasps

Item No.	Blade	Length (in.)
MB110R	38 x 5.7 mm	6 1/2"



MB110R

1/1

## DINGMAN Malleable Passing Needle

Item No.	Tip	Length (in.)
MB116R	Curved	6 3/4"



MB116R

1/1

## PARKES Nasal Rasps

Item No.	Tip	Blade	Length (in.)
MB330R	Fine	34 x 8 mm	7 7/8"

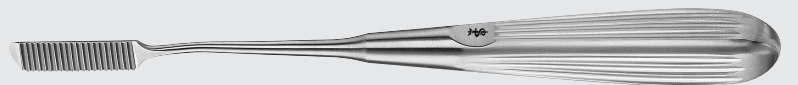

MB330R

1/2

# Mallets



MB303R

1/2

## CRANE Mallets

Item No.	Length (in.)
MB303R	6 1/4"

# Curettes



MB542R

1/2

## DAWSON-YUHL Curettes

Item No.	Cup	Length (in.)
MB542R	Reverse Angle	11"

MB415R - MB417R

1/2

## HIBBS Curettes

Item No.	Cup	Length (in.)
MB415R	Small	8"
MB416R	Medium	8"
MB417R	Large	8"



MB316R

1/2

## VOGEL Adenoid Curettes

Item No.	Size	Length (in.)
MB316R	Infant 7 mm	8 1/2"



# Curettes

## GUILFORD-WRIGHT Micro Bone Curettes

Item No.	Jaw	Length (in.)
MB039R	2.1 x 1.2 mm Slightly Angled	5 1/8"



MB039R

1/1

## PRATT Ethmoid Curettes

Item No.	Jaws	Length (in.)
MB117R	One Solid Cup and One Fenestrated Cup	9 1/4"



MB117R

1/2

## KELLY-GRAY Uterine Curettes

Item No.	Size	Length (in.)
MB375R	1	9 1/2"
MB376R	2	9 1/2"
MB377R	3	9 1/2"
MB378R	4	9 1/2"

Picture not available

# Director



MB336R

1/1

**Grooved Director with Tongue Tie**

Item No.	Length (in.)
MB336R	4 1/2"

# Dissectors



MB060R

1/2

**CRILE Hook and Dissectors**

Item No.	Length (in.)
MB060R	11 3/4"

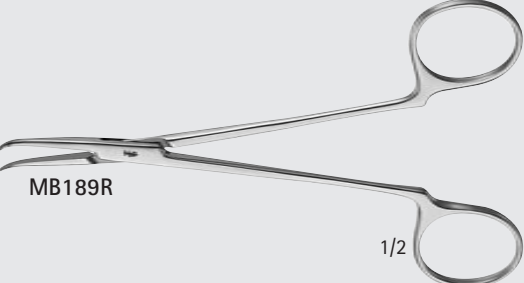

MB189R

1/2

**McCABE Facial Nerve Dissectors**

Item No.	Jaw	Length (in.)
MB189R	Angled 25 mm	5 1/2"



MB297R

1/2

**HAJEK-BALLENGER Septum Elevator and Dissectors**

Item No.	Jaw	Length (in.)
MB297R	Double-end Sharp and Blunt Blades	7 1/2"





# Dissectors

## CRABTREE "JIMMY" Dissectors

Item No.	Blade	Length (in.)
MB332R	Large Tip 2 mm	6 1/2"
MB333R	Small Tip 1.3 mm	6 1/2"



## McCABE Flap Knife Dissectors

Item No.	Blade Angle	Length (in.)
MB176R	20° & 40°	7 1/4"

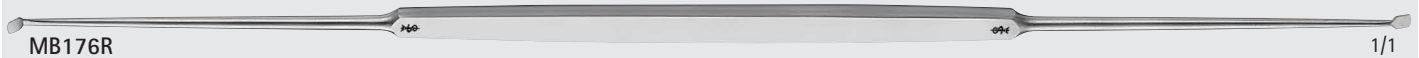

## Rogers Submucous Dissectors

Item No.	Length (in.)
MB312R	8 3/4"



## Pierce Submucous Dissectors

Item No.	Length (in.)
MB313R	7 1/2"



# Elevators

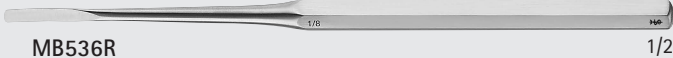

MB536R 1/2

**KEY Periosteal Elevators**

Item No.	Blade	Length (in.)
MB536R	3.1 mm	6 3/4"



MB190R 1/2

**CUSHING Elevators**

Item No.	Blade	Length (in.)
MB190R	Narrow Sharp 8 mm	7 3/4"

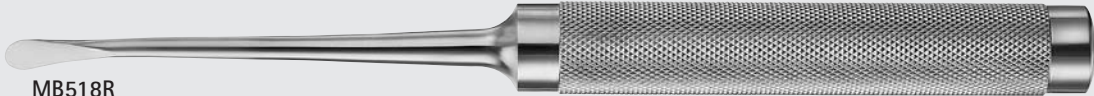

MB518R 1/2

**COBB Periosteal Elevators**

Item No.	Jaw	Blade	Length (in.)
MB518R	Curved	7 mm	12"

# Excavators



MB571R - MB572R 1/1

**HOUGH "Whirlybird" Excavators**

Item No.	JAW	Length (in.)
MB571R	Curved Left	6"
MB572R	Curved Right	6"



# Hooks

## Bone Hooks

Item No.	Hook	Length (in.)
MB418R	Sharp	9"

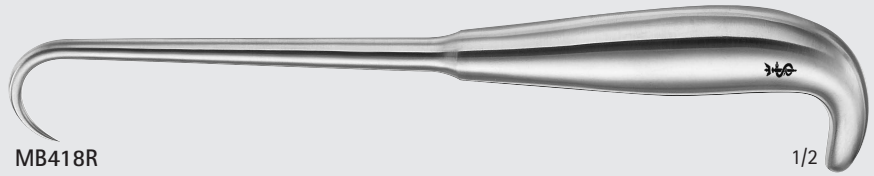

MB418R

1/2

# Impactors

## DAWSON-YUHL Impactors

Item No.	Jaw	Length (in.)
MB545R	Serrated	11 1/4"



MB545R

1/2

# Osteotomes

## CHERRY Osteotomes

Item No.	Blade	Length (in.)
MB590R	Straight 3 mm	8"
MB591R	Straight 4 mm	8"
MB592R	Straight 5 mm	8"
MB593R	Straight 6 mm	8"
MB594R	Straight 7 mm	8"



MB590R - MB594R

1/2

# Osteotomes

## Hexagonal Handle Osteotomes

Item No.	Blade	Length (in.)
MB404R	2 mm	6 1/4"
MB405R	3 mm	6 1/4"
MB406R	4 mm	6 1/4"
MB407R	5 mm	6 1/4"
MB408R	6 mm	6 1/4"
MB409R	7 mm	6 1/4"
MB410R	8 mm	6 1/4"
MB411R	9 mm	6 1/4"
MB412R	10 mm	6 1/4"
MB413R	11 mm	6 1/4"
MB373R	12 mm	6 1/4"

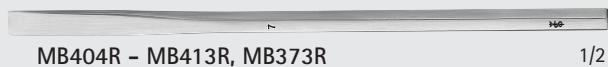

MB404R - MB413R, MB373R

1/2

## CONVERSE Osteotomes

Item No.	Blade	Length (in.)
MB398R	Straight 2 mm	7"
MB399R	Straight 4 mm	7"
MB400R	Straight 6 mm	7"
MB401R	Straight 8 mm	7"
MB402R	Straight 10 mm	7"
MB403R	Straight 12 mm	7"



MB398R - MB403R

1/2

## RUBIN Osteotomes

Item No.	Blade	Length (in.)
MB388R	10 mm	6 1/2"
MB389R	14 mm	6 1/2"



MB388R - MB389R

1/2

# Picks

## GUILFORD-WRIGHT Stapes Picks

Item No.	Tip	Length (in.)
MB044R	Angled 90°	5 1/2"



MB044R

1/1



# Picks

## AUSTIN Picks

Item No.	Tip	Length (in.)
MB055R	1 mm Angled 45°	6 1/4"



1/1

# Scoops

## FERGUSON Gall Stone Scoops, Double-end

Item No.	Jaw	Blade	Length (in.)
MB697R	Double End	#1	9 1/2"
MB698R	Double End	#2	9 1/2"
MB699R	Double End	#3	9 1/2"



MB697R - MB699R

1/2

# Gouges

## PARKES Hump Gouges

Item No.	Blade	Length (in.)
MB108R	Straight	7"

MB108R - Picture not available

# Tuning Fork



HARTMANN Tuning Fork

Item No.	Frequency
MB575A	C64

MB575A

# Wire Cutters

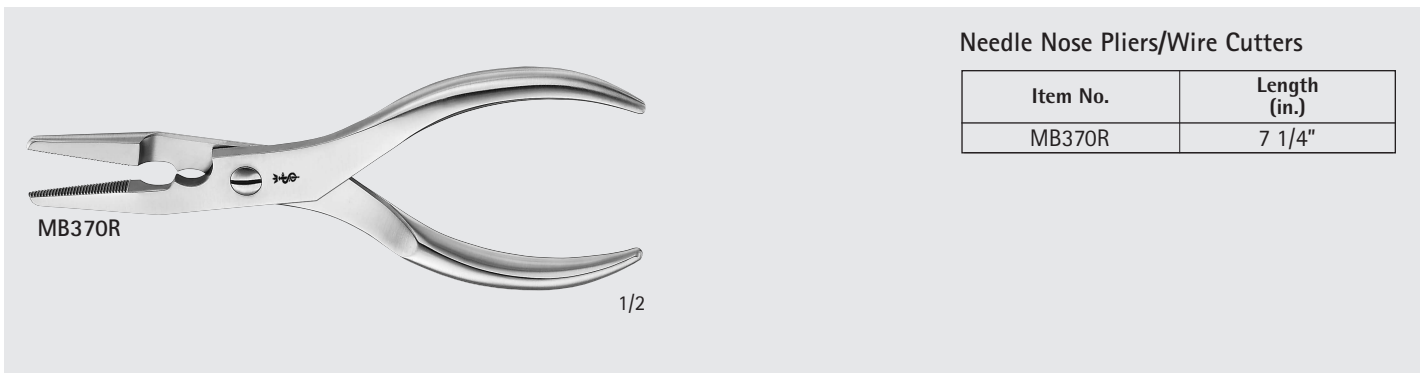

Needle Nose Pliers/Wire Cutters

Item No.	Length (in.)
MB370R	7 1/4"

MB370R

1/2

# Wire Twister

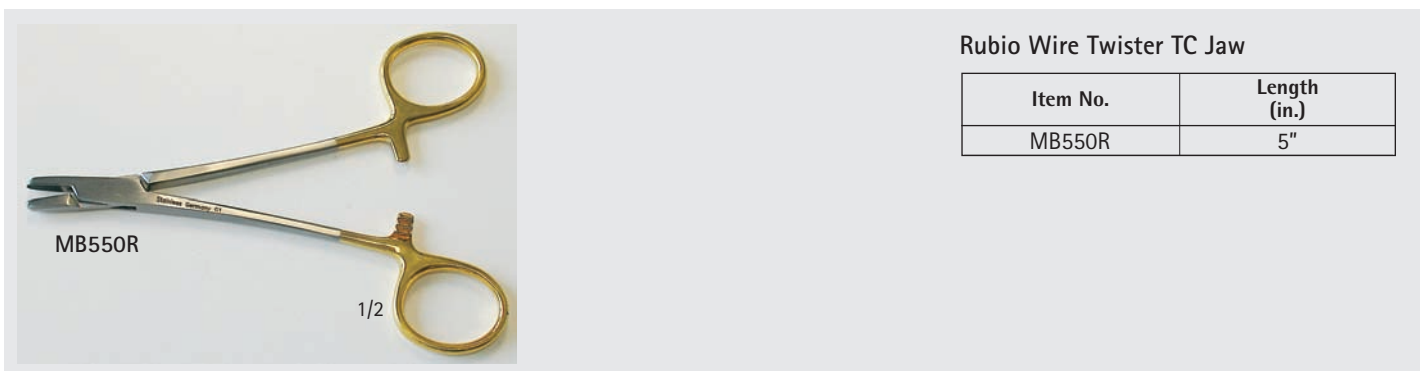

Rubio Wire Twister TC Jaw

Item No.	Length (in.)
MB550R	5"

MB550R

1/2



# Miscellaneous

## JACOBSON Endarterectomy Spatulas

Item No.	Blade	Length (in.)
MB063R	Straight	7"



MB063R

1/1

# V. Mueller – Aesculap Cross Reference List

V. Mueller Item No.	Aesculap Item No.	Aesculap Product Description
AS169	MB051R	Yankauer Suction Tube Curved 14"
AS170	MB052R	Suction Handle W/thumb Control 6-7/8"
AS173	MB053R	Yankauer Suction Tube 6-5/8"
AU12227	MB049R	Wiet Otologic Scissors Straight Blade Bayonet Shape 6-1/2"
AU13300	MB039R	Guilford Wright Curette 2.1x1.2 mm 5-1/8"
AU13455	MB044R	Guilford Wright Stapes Pick 90° Heavy 5-1/2"
AU13790	MB282R	Paparella Sickle Knife Right-Curve #14 6-1/2"
AU13792	MB283R	Paparella Sickle Knife Left-Curve #15 6-1/2"
AU14190	MB054R	Wullstein Retractor 3x3-prong blunt 4-1/8"
AU15030001	MB381R	Baron Suction Tube 5Fr 4"
AU15032001	MB380R	Baron Suction Tube 3Fr 4"
AU15034001	MB382R	Baron Suction Tube 7Fr 4"
AU15235	MB614R	House Suction Straight 18Ga 4-1/8"
AU15240	MB615R	House Suction Straight 20Ga 4-1/8"
AU15245	MB616R	House Suction Straight 22Ga 4-1/8"
AU20700	MB571R	Hough Whirlybird Excavator Curved Left 6"
AU20705	MB572R	Hough Whirlybird Excavator Curved Right 6"
AU21014	MB055R	Austin Pick 45° 1 mm 6-1/4"
AU5000	MB575A	Hartmann Tuning Fork C64HZ
AU5101	MB242R	Gruber Ear Speculum Small
AU5102	MB243R	Gruber Ear Speculum Medium
AU5103	MB244R	Gruber Ear Speculum Large
BE3000	MB366R	Jackson Velvet Eye Aspirating Tube 10"
BE3002	MB367R	Jackson Velvet Eye Aspiration Tube 16-3/8"
BE3003	MB369R	Jackson Velvet Eye Aspirating Tube 181/8"
CH1030-001	MB842R	Henly Retractor Center Blade Small 3/4x5/8"
CH1030-002	MB843R	Henly Retractor Center Blade Medium 1x5/8"
CH1030-003	MB844R	Henly Retractor Center Blade Large 1-1/4x5/8"
CH1030-004	MB845R	Henly Retractor Side Blade 4-prong Blunt 1x1"
CH1030-005	MB846R	Henly Retractor Side Blade 4-prong Blunt 2x1"
CH1030-006	MB847R	Henly Retractor Side Blade 4-prong Blunt 3x7/8"
CH1030-007	MB848R	Henly Retractor Center Blade X-large 3x5/8"
CH1031	MB849R	Henly Retractor Frame Only 7"
CH1570	MB057R	Babcock Thoracic Tissue Forceps 9-1/2"
CH1610	MB056R	Lovelace Lung Forceps Angled 8"
CH1721-001	MB058R	Kantrowitz Thoracic Clamp Right Angle 6-3/8"
CH1730-006	MB059R	Mixer Thoracic Clamp Right Angle 14"
CH2006-002	MB206R	TC Metzenbaum Scissors Curved Delicate S/S 9-1/4"
CH2496	MB210R	TC Cooley Intracardiac Needle Holder 9"
CH2535	MB550R	Rubio Wire Twister TC Jaw 5"
CH2600	MB060R	Crile Hook/Dissector 11-3/4"
CH5197	MB061R	Kantrowitz Dressing Forceps Right Angle 12"





V. Mueller Item No.	Aesculap Item No.	Aesculap Product Description
CH5908	MB062R	DeBakey Tissue Forceps 2 mm Jaw 14"
CH6035	MB586R	Colley Bulldog Clamp Curved Serrated 1-3/4"
CH6036	MB587R	Cooley Bulldog Clamp Curved Serrated 2-1/2"
CH6037	MB588R	Cooley Bulldog Clamp Curved Serrated 3"
CH6092	MB523R	Gregory DeBakey Bridge Clamp 45° 70 mm 4-3/4"
CH6300	MB350R	Cooley Coartaction Clamp Straight 8-3/4"
CH6355	MB348R	Cooley Clamp Curved 8-1/4"
CH6442	MB349R	Cooley Aorta Clamp Curved 10"
CH6620	MB528R	Cooley Multi-purpose Clamp Curved 8"
CH7972	MB580R	Cooley Caval Occlusion Clamp 28Fr 8-1/4"
CH7974	MB581R	Cooley Caval Occlusion Clamp 32Fr 8-1/4"
CH7974-001	MB582R	Cooley Caval Occlusion Clamp 34Fr 8-1/4"
CH8105-001	MB047R	Ross Aortic Valve Retractor #1 10"
CH8105-002	MB048R	Ross Aortic Valve Retractor #3 9-3/4"
CH8105-003	MB700R	Ross Aortic Valve Retractor #3 10-1/4"
CH8105-004	MB701R	Ross Aortic Valve Retractor #4 10-1/4"
CH8105-005	MB702R	Ross Aortic Valve Retractor #5 10-1/4"
CH8105-006	MB703R	Ross Aortic Valve Retractor #6 10-1/4"
CH8580	MB063R	Jacobson Endarterectomy Spatula Straight 7"
CH8591	MB362R	Jacobson Needle Holder TC Straight W/Round Catch 8-3/4"
CH8689	MB064R	Valve Leaflet Excision Scissors 45° 5-3/4"
CH8690	MB065R	Arteriotomy Scissors 60° 5-3/8"
CV5020	MB091R	Fogarty Hydragrip Clamp Straight Jaw 6-1/2"
CV5025	MB092R	Fogarty Hydragrip Clamp Angled Jaw 4-5/8"
CV5040	MB093R	Fogarty Hydragrip Clamp Slight Angled Jaw 8-3/4"
CV5045	MB094R	Fogarty Hydragrip Clamp Strong Angled Jaw 8-1/2"
CV5050	MB095R	Fogarty Hydragrip Clamp Angled Jaw 9-1/4"
CV5055	MB096R	Fogarty Hydragrip Clamp Straight Jaw 12-1/4"
CV5110	MB097R	Fogarty Spring Clip Applicator Forceps 7-1/4"
GL1702	MB376R	Kelly Gray Uterine Curette Size #2 9-1/2"
GL30	MB066R	Pederson Vaginal Speculum Small
GL33	MB067R	Peterson Vaginal Speculum Large
GL3602-003	MB354R	Z-type Uterine Hysterectomy Clamp Curved 9-1/2"
GL3602-004	MB355R	Z-type Uterine Hysterectomy Clamp Angled 9-1/2"
GL3604-002	MB188R	Z-type Uterine Hysterectomy Clamp Slight-Curve 12"
GL3604-003	MB183R	Z-type Uterine Hysterectomy Clamp Curved 12"
GL3604-004	MB184R	Z-type Uterine Hysterectomy Clamp Angled 12"
GL3606-001	MB185R	Z-type Uterine Hysterectomy Clamp Straight 14"
GL480	MB068R	De Lee Universal Retractor 9-1/2"
GL652	MB098R	Foerster Sponge Forceps Serrated 12"
GL654	MB099R	Foerster Sponge Forceps Serrated 14"
MO1720	MB533R	McHenry Forceps 8"

# V. Mueller – Aesculap Cross Reference List

V. Mueller Item No.	Aesculap Item No.	Aesculap Product Description
MO1730	MB103R	Tonsil Clamp 14-1/2"
NL1074	MB190R	Cushing Elevator Sharp 8 mm 7-3/4"
NL6570-003	MB590R	Cherry Osteotome Straight 3 mm 8"
NL6570-004	MB591R	Cherry Osteotome Straight 4 mm 8"
NL6570-005	MB592R	Cherry Osteotome Straight 5 mm 8"
NL6570-006	MB593R	Cherry Osteotome Straight 6 mm 8"
NL6570-007	MB594R	Cherry Osteotome Straight 7 mm 8"
NL6750	MB417R	Hibbs Curette Large Cup 8"
NL6751	MB416R	Hibbs Curette Medium Cup 8"
NL6752	MB415R	Hibbs Curette Small Cup 8"
NL7020	MB303R	Crane Mallet 6-1/4"
NL7100-010	MB542R	Dawson-Yuhl Curette 11" Rev Angle #1
NL7100-019	MB545R	Dawson-Yuhl Impactor Straight Serrated 11-1/4"
OP0702	MB104R	Knife Handle #3H Hexagonal 4"
OS1079-001	MB536R	Key Periosteal Elevator 6-3/4"
OS5241	MB147R	Martin Cartilage Scissors Curved Serrated 8"
OS5505	MB456R	Bunnell Dissecting Probe Angled 5-1/2"
OS5515	MB363R	Bunnell Tendon Passer & Forwarding Probe 7-3/8"
OS5526-002	MB105R	Brand Tendon Tunneling Forceps 9-1/4"
OS6000	MB191R	Self-Retaining Retractor W/3lb Weight
OS6100	MB106R	Hercules Plaster Shears 7-1/2"
RH1285	MB107R	Converse Nasal Retractor 4-1/2"
RH1445	MB398R	Converse Osteotome Straight 2 mm 7"
RH1446	MB399R	Converse Osteotome Straight 4 mm 7"
RH1447	MB400R	Converse Osteotome Straight 6 mm 7"
RH1448	MB401R	Converse Osteotome Straight 8 mm 7"
RH1449	MB402R	Converse Osteotome Straight 10 mm 7"
RH1450	MB403R	Converse Osteotome Straight 12 mm 7"
RH1457	MB108R	Parkes Hump Gouge Straight 10 mm 7"
RH1465-10	MB412R	Osteotome W/ Hex Handle 10 mm 6-1/4"
RH1465-11	MB413R	Osteotome W/ Hex Handle 11 mm 6-1/4"
RH1465-12	MB373R	Osteotome W/ Hex Handle 12 mm 6-1/4"
RH1465-2	MB404R	Osteotome W/ Hex Handle 2 mm 6-1/4"
RH1465-3	MB405R	Osteotome W/ Hex Handle 3 mm 6-1/4"
RH1465-4	MB406R	Osteotome W/ Hex Handle 4 mm 6-1/4"
RH1465-5	MB407R	Osteotome W/ Hex Handle 5 mm 6-1/4"
RH1465-6	MB408R	Osteotome W/ Hex Handle 6 mm 6-1/4"
RH1465-7	MB409R	Osteotome W/ Hex Handle 7 mm 6-1/4"
RH1465-8	MB410R	Osteotome W/ Hex Handle 8 mm 6-1/4"
RH1465-9	MB411R	Osteotome W/ Hex Handle 9 mm 6-1/4"
RH1585	MB189R	McCabe Facial Nerve Dissector 5-1/2"
RH1620-001	MB174R	Joseph Scissors Straight Serrated S/S 5"



V. Mueller Item No.	Aesculap Item No.	Aesculap Product Description
RH1630-001	MB175R	Joseph Scissors Curved Serrated S/S 5"
RH1651-002	MB207R	TC Metzenbaum Scissors Curved Delicate S/S 5-3/4"
RH1652	MB150R	Metzenbaum Lipsett Scissors Curved 5-1/2"
RH1666-001	MB109R	Kaye Facelift Scissors Curved 7-1/2"
RH1691	MB540R	TC Fomon Dorsal Scissors 30° 5-1/4"
RH1786	MB388R	Rubin Osteotome 10 mm 6-1/2"
RH1788	MB389R	Rubin Osteotome 14 mm 6-1/2"
RH2055	MB110R	Maltz Anderson Nasal Rasp 6-1/2"
RH2069	MB330R	Parkes Nasal Rasp Fine 8"
RH2750	MB116R	Dingman Passing Needle Curved 6-3/4"
RH3640	MB117R	Pratt Ethmoid Curette Double End 9-1/4"
RH41	MB318R	Sonnenschein Nasal Speculum Medium 6"
RH4400	MB316R	Vogel Adenoid Curette Infant Size 7 mm 8-1/2"
RH760	MB118R	Ballenger Swivel Knife Straight #4 7-3/4"
RH761	MB119R	Ballenger Swivel Knife Straight #3 7-3/4"
RH790	MB297R	Hajek Ballenger Septum Elevator/Dissector 7-1/2"
SU10500	MB120R	Mixter Gall Duct Forceps Curved 6-1/4"
SU10510	MB126R	Shallcross Cystic Duct Forceps Curved 6-7/8"
SU11020001	MB697R	Ferguson Gall Scoop Double End Size #1 9-1/2"
SU11020002	MB698R	Ferguson Gall Scoop Double End Size #2 9-1/2"
SU11020003	MB699R	Ferguson Gall Scoop Double End Size #3 9-1/2"
SU1403-003	MB127R	Knife Handle #3LA 8"
SU1816	MB149R	Mayo Sims Dissecting Scissors Straight B/B 7-3/4"
SU1935	MB148R	Mayo Dissecting Scissors W/Heavy Blade Large Rings 14"
SU220	MB274R	Rectal Speculum 2-1/2"
SU2758	MB128R	Pean Artery Forceps Straight 12"
SU2768	MB180R	Pean Artery Forceps Curved 12"
SU2780	MB182R	Carmalt Artery Forceps Curved 12"
SU2808	MB172R	Rochester-Ochsner Forceps Straight 1x2 teeth 14"
SU3105	MB129R	Mayo Collins Appendectomy Retractor 6-3/4"
SU3670	MB584R	Roux Retractor Double End 25x35 mm 6-1/8"
SU3671	MB585R	Roux Retractor Double End 29x40 mm 6-1/2"
SU5003	MB136R	Babcock Tissue Holding Forceps 12"
SU5004	MB137R	Babcock Tissue Holding Forceps 14"
SU5011	MB338R	TC Babcock Forceps 8-1/4"
SU60	MB284R	Brinkerhoff Rectal Speculum 4-1/2"
SU6100	MB138R	Glassman Non-crushing Gastrointestinal Clamp Straight 9-1/4"
SU6110	MB139R	Glassman Non-crushing Gastrointestinal Clamp Angle 9-1/4"
SU6129	MB130R	Glassman Anterior Resection Clamp 9-3/4"

# Jarit - Aesculap Cross Reference List

Jarit Item No.	Aesculap Item No.	Aesculap Product Description
101-253	MB207R	TC Metzenbaum Scissors Curved Delicate S/S 5-3/4"
101-279	MB206R	TC Metzenbaum Scissors Curved Delicate S/S 9-1/4"
110-171	MB127R	Knife Handle #3LA 8"
110-194	MB104R	Knife Handle #3H Hexagonal 4"
121-214	MB210R	TC Cooley Intracardiac Needle Holder 9"
121-250	MB550R	Rubio Wire Twister TC Jaw 5"
121-255	MB456R	Bunnell Dissecting Probe Angled 5-1/2"
135-191	MB338R	TC Babcock Forceps 8-1/4"
135-195	MB057R	Babcock Thoracic Tissue Forceps 9-1/2"
135-196	MB136R	Babcock Tissue Holding Forceps 12"
140-154	MB697R	Ferguson Gall Scoop Double End Size #1 9-1/2"
140-155	MB698R	Ferguson Gall Scoop Double End Size #2 9-1/2"
140-156	MB699R	Ferguson Gall Scoop Double End Size #3 9-1/2"
205-532	MB845R	Henly Retractor Side Blade 4-prong Blunt 1x1"
205-534	MB846R	Henly Retractor Side Blade 4-prong Blunt 2x1"
205-536	MB847R	Henly Retractor Side Blade 4-prong Blunt 3x7/8"
205-540	MB842R	Henly Retractor Center Blade Small 3/4x5/8"
205-542	MB843R	Henly Retractor Center Blade Medium 1x5/8"
205-544	MB844R	Henly Retractor Center Blade Large 1-1/4x5/8"
225-500	MB191R	Self-Retaining Retractor W/3lb Weight
250-420	MB536R	Key Periosteal Elevator 6-3/4"
270-150	MB147R	Martin Cartilage Scissors Curved Serrated 8"
285-398	MB190R	Cushing Elevator Sharp 8 mm 7-3/4"
285-480	MB380R	Baron Suction Tube 3Fr 4"
285-482	MB381R	Baron Suction Tube 5Fr 4"
285-484	MB382R	Baron Suction Tube 7Fr 4"
305-220	MB056R	Lovelace Lung Forceps Angled 8"
305-294	MB058R	Kantrowitz Thoracic Clamp Right Angle 6-3/8"
305-397	MB182R	Carmalt Artery Forceps Curved 12"
320-108	MB062R	DeBakey Tissue Forceps 2 mm Jaw 14"
320-141	MB586R	Colley Bulldog Clamp Curved Serrated 1-3/4"
320-143	MB587R	Cooley Bulldog Clamp Curved Serrated 2-1/2"
320-145	MB588R	Cooley Bulldog Clamp Curved Serrated 3"
320-179	MB523R	Gregory DeBakey Bridge Clamp 45° 70 mm 4-3/4"
320-244	MB349R	Cooley Aorta Clamp Curved 10"
320-397	MB350R	Cooley Coartaction Clamp Straight 8-3/4"
320-564	MB580R	Cooley Caval Occlusion Clamp 28Fr 8-1/4"
320-568	MB581R	Cooley Caval Occlusion Clamp 32Fr 8-1/4"
320-570	MB582R	Cooley Caval Occlusion Clamp 34Fr 8-1/4"
325-141	MB139R	Glassman Non-crushing Gastrointestinal Clamp Angled 9-1/4"
375-141	MB244R	Gruber Ear Speculum Large
400-105	MB318R	Sonnenschein Nasal Speculum Medium 6"



Jarit Item No.	Aesculap Item No.	Aesculap Product Description
400-260	MB119R	Ballenger Swivel Knife Straight #3 7-3/4"
400-261	MB118R	Ballenger Swivel Knife Straight #4 7-3/4"
400-275	MB297R	Hajek Ballenger Septum Elevator/Dissector 7-1/2"
410-280	MB398R	Converse Osteotome Straight 2 mm 7"
410-281	MB399R	Converse Osteotome Straight 4 mm 7"
410-282	MB400R	Converse Osteotome Straight 6 mm 7"
410-283	MB401R	Converse Osteotome Straight 8 mm 7"
410-284	MB402R	Converse Osteotome Straight 10 mm 7"
410-286	MB403R	Converse Osteotome Straight 12 mm 7"
420-136	MB110R	Maltz Anderson Nasal Rasp 6-1/2"
420-138	MB330R	Parkes Nasal Rasp Fine 8"
475-165	MB284R	Brinkerhoff Rectal Speculum 4-1/2"
500-125	MB067R	Peterson Vaginal Speculum Large
500-197	MB068R	De Lee Universal Retractor 9-1/2"
505-286	MB354R	Z-type Uterine Hysterectomy Clamp Curved 9-1/2"
505-287	MB355R	Z-type Uterine Hysterectomy Clamp Angled 9-1/2"
505-289	MB188R	Z-type Uterine Hysterectomy Clamp Slight Curve 12"
505-290	MB183R	Z-type Uterine Hysterectomy Clamp Curved 12"
505-291	MB184R	Z-type Uterine Hysterectomy Clamp Angle 12"
505-292	MB185R	Z-type Uterine Hysterectomy Clamp Straight 14"

# Pilling Weck – Aesculap Cross Reference List

Pilling Weck Item No.	Aesculap Item No.	Aesculap Product Description
29550	MB054R	Wullstein Retractor 3x3-prong Blunt 4-1/8"
30180	MB318R	Sonnenschein Nasal Speculum Medium 6"
36111	MB118R	Ballenger Swivel Knife Straight #4 7-3/4"
51132	MB398R	Converse Osteotome Straight 2 mm 7"
51138	MB401R	Converse Osteotome Straight 8 mm 7"
51140	MB402R	Converse Osteotome Straight 10 mm 7"
51210	MB388R	Rubin Osteotome 10 mm 6-1/2"
51214	MB389R	Rubin Osteotome 14 mm 6-1/2"
72110	MB316R	Vogel Adenoid Curette Infant Size 7 mm 8-1/2"
175005	MB136R	Babcock Tissue Holding Forceps 12"
175011	MB182R	Carmalt Artery Forceps Curved 11-3/4"
175027	MB062R	DeBakey Tissue Forceps 2 mm Jaw 14"
175100	MB172R	Rochester Ochsner Forceps Straight 1x2 teeth 14"
175115	MB051R	Yankauer Suction Tube Curved 14"
175118	MB184R	Z-type Uterine Hysterectomy Clamp Angled 12"
175121	MB185R	Z-type Uterine Hysterectomy Clamp Straight 14"
175122	MB188R	Z-type Uterine Hysterectomy Clamp Slight Curve 12"
175124	MB183R	Z-type Uterine Hysterectomy Clamp Curved 12"
202082	MB284R	Brinkerhoff Rectal Speculum Large 4-1/2"
202105	MB274R	Fransler Rectal Speculum 2-1/2"
212010	MB066R	Pederson Vaginal Speculum Small
212011	MB067R	Peterson Vaginal Speculum Large
212350	MB068R	De Lee Universal Retractor 9-1/2"
351349	MB550R	Rubio Wire Twister TC Jaw 5"
351650	MB581R	Cooley Caval Occlusion Clamp 32Fr 8-1/4"
351654	MB582R	Cooley Caval Occlusion Clamp 34Fr 8-1/4"
352952	MB127R	Knife Handle #3LA 8"
353077	MB523R	Gregory DeBakey Bridge Clamp 45° 70 mm 4-3/4"
353112	MB587R	Cooley Bulldog Clamp Curved Serrated 2-1/2"
353115	MB588R	Cooley Bulldog Clamp Curved Serrated 3"
354987	MB210R	TC Cooley Intracardiac Needle Holder 9"
356065	MB348R	Cooley Clamp Curved 8-1/4"
358340	MB190R	Cushing Elevator Sharp 8 mm 7-3/4"
411700	MB380R	Baron Suction Tube 3Fr 4"
411702	MB381R	Baron Suction Tube 5Fr 4"
411704	MB382R	Baron Suction Tube 7Fr 4"
431810	MB297R	Hajek Ballenger Septum Elevator/Dissector 7-1/2"
441220	MB409R	Osteotome W/ Hex Handle 6-1/4" 7 mm
441230	MB398R	Converse Osteotome Straight 2 mm 7"
441232	MB399R	Converse Osteotome Straight 4 mm 7"
441295	MB388R	Rubin Osteotome 10 mm 6-1/2"
441299	MB389R	Rubin Osteotome 14 mm 6-1/2"



Pilling Weck Item No.	Aesculap Item No.	Aesculap Product Description
441502	MB110R	Maltz Anderson Nasal Rasp 6-1/2"
456006	MB104R	Knife Handle #3H Hexagonal 4"
464707	MB207R	TC Metzenbaum Scissors Curved Del S/S 5-3/4"
464726	MB206R	TC Metzenbaum Scissors Curved Del S/S 9-1/4"
496180	MB056R	Lovelace Lung Forceps Angled 8"
497230	MB697R	Ferguson Gall Scoop Double End Size #1 9-1/2"
497231	MB698R	Ferguson Gall Scoop Double End Size #2 9-1/2"
497232	MB699R	Ferguson Gall Scoop Double End Size #3 9-1/2"
500412	MB338R	TC Babcock Forceps 8-1/4"
507033	MB367R	Jackson Velvet Eye Aspiration Tube 4 mm 16-3/8"
582160	MB303R	Crane Mallet 6-1/4"
584152	MB415R	Hibbs Curette Small Cup 8"
584154	MB416R	Hibbs Curette Medium Cup 8"
586250	MB536R	Key Periosteal Elevator 6-3/4"
594394	MB060R	Crile Hook/Dissector 11-3/4"
730135	MB274R	Rectal Speculum 2-1/2"
790320	MB147R	Martin Cartilage Scissors Curved Serrated 8"

# Codman – Aesculap Cross Reference List

Codman Item No.	Aesculap Item No.	Aesculap Product Description
19-8121	MB580R	Cooley Caval Occlusion Clamp 28Fr 8-1/4"
19-8122	MB581R	Cooley Caval Occlusion Clamp 32Fr 8-1/4"
30-8092	MB182R	Carmalt Artery Forceps Curved 11-3/4"
30-8093	MB180R	Pean Artery Forceps Curved 12"
36-1001	MB362R	TC Jacobson Needle Holder Straight 8-3/4"
36-2023	MB550R	Rubio Wire Twister TC Jaw 5"
36-5030	MB207R	TC Lahey Metzenbaum Scissors Curved Delicate S/S 5-3/4"
36-5034	MB206R	TC Metzenbaum Scissors Curved Delicate S/S 9-1/4"
37-1054	MB587R	Cooley Bulldog Clamp Curved Serrated 2-1/2"
37-1055	MB588R	Cooley Bulldog Clamp Curved Serrated 3"
37-1062	MB523R	Gregory DeBakey Bridge Clamp 45° 70 mm 4-3/4"
37-1260	MB350R	Cooley Coartaction Clamp Straight 50 mm 8-3/4"
37-1400	MB349R	Cooley Aorta Clamp Curved 10"
37-4017	MB139R	Glassman Non-crushing Gastrointestinal Clamp Angled 9-1/4"
37-4018	MB138R	Glassman Non-crushing Gastrointestinal Clamp Straight 9-1/4"
40-6770	MB119R	Ballenger Swivel Knife Straight #3 7-3/4"
50-5575	MB068R	De Lee Universal Retractor 9-1/2"
65-1092	MB190R	Cushing Elevator Sharp 8 mm 7-3/4"
65-6562	MB297R	Hajek Ballenger Septum Elevator/Dissector 6-3/4"
79-5555	MB274R	Rectal Speculum 2-1/2"





# Index

Item No.	Page	Item No.	Page	Item No.	Page	Item No.	Page
MB039R	31	MB104R	27	MB176R	33	MB297R	32
MB044R	36	MB105R	13	MB180R	11	MB303R	30
MB049R	4	MB106R	6	MB181R	11	MB308R	14
MB051R	28	MB107R	20	MB182R	12	MB312R	33
MB052R	28	MB108R	37	MB183R	18	MB313R	33
MB053R	28	MB109R	4	MB184R	18	MB316R	30
MB054R	20	MB110R	29	MB185R	18	MB318R	26
MB055R	37	MB116R	29	MB186R	18	MB330R	29
MB056R	9	MB117R	31	MB187R	18	MB332R	33
MB057R	9	MB118R	8	MB188R	18	MB333R	33
MB058R	15	MB119R	8	MB189R	32	MB336R	32
MB059R	9	MB120R	11	MB190R	34	MB338R	12
MB060R	32	MB126R	11	MB191R	22	MB348R	19
MB061R	10	MB127R	27	MB194R	23	MB349R	19
MB062R	10	MB128R	11	MB195R	23	MB350R	17
MB063R	39	MB129R	21	MB196R	24	MB352R	18
MB064R	4	MB130R	15	MB200R	19	MB353R	18
MB065R	4	MB136R	12	MB205R	5	MB354R	18
MB066R	25	MB137R	12	MB206R	5	MB355R	18
MB067R	26	MB138R	16	MB207R	5	MB362R	7
MB068R	20	MB139R	16	MB208R	14	MB363C	27
MB091R	15	MB140R	6	MB210R	7	MB366R	28
MB092R	15	MB146R	6	MB211R	14	MB367R	28
MB093R	15	MB147R	4	MB242R	25	MB368R	28
MB094R	15	MB148R	5	MB243R	25	MB369R	28
MB095R	15	MB149R	5	MB244R	25	MB370R	38
MB096R	15	MB150R	6	MB274R	26	MB373R	36
MB097R	14	MB171R	6	MB282R	8	MB375R	31
MB098R	10	MB172R	12	MB283R	8	MB376R	31
MB099R	10	MB174R	5	MB284R	25	MB377R	31
MB103R	16	MB175R	5	MB289R	13	MB378R	31



# Index

Item No.	Page	Item No.	Page	Item No.	Page
MB379R	23	MB523R	17	MB701R	21
MB380R	28	MB528R	19	MB702R	21
MB381R	28	MB533R	13	MB703R	21
MB382R	28	MB536R	34	MB842R	22
MB388R	36	MB540R	5	MB843R	22
MB389R	36	MB542R	30	MB844R	22
MB398R	36	MB545R	35	MB845R	22
MB399R	36	MB550R	38	MB846R	22
MB400R	36	MB571R	34	MB847R	22
MB401R	36	MB572R	34	MB848R	22
MB402R	36	MB575A	38	MB849R	23
MB403R	36	MB580R	17	MD071R	24
MB404R	36	MB581R	17	MD072R	24
MB405R	36	MB582R	17		
MB406R	36	MB584R	21		
MB407R	36	MB585R	21		
MB408R	36	MB586R	16		
MB409R	36	MB587R	16		
MB410R	36	MB588R	16		
MB411R	36	MB590R	35		
MB412R	36	MB591R	35		
MB413R	36	MB592R	35		
MB415R	30	MB593R	35		
MB416R	30	MB594R	35		
MB417R	30	MB614R	28		
MB418R	35	MB615R	28		
MB448R	23	MB616R	28		
MB449R	24	MB697R	37		
MB456R	27	MB698R	37		
MB514R	23	MB699R	37		
MB518R	34	MB700R	21		



# AESCULAP®

All rights reserved. Technical alterations are possible. This leaflet may be used for no other purposes than offering, buying and selling of our products. No part may be copied or reproduced in any form. In the case of misuse we retain the rights to recall our catalogs and price lists and to take legal actions.

©2008 AESCULAP. ALL RIGHTS RESERVED. PRINTED IN THE USA. DOC766 3M 7/08  
Aesculap is an equal opportunity employer

**B | BRAUN**  
SHARING EXPERTISE

**Aesculap, Inc.**

3773 Corporate Parkway  
Center Valley, PA 18034  
Phone: 800-282-9000

[www.aesculapusa.com](http://www.aesculapusa.com)